

INSTANT
BOILING WATER
INSTANT
HOT WATER

sustainable comfort

CLOSE-IN® | -UP
H₂O TAP
3-IN-1 TAP



DAALDEROP COMPLETES YOUR KITCHEN

Convenience and design. The keystones in today's kitchen. Design is almost self-explanatory. The kitchen is an important style element in your home. One you enjoy constantly, by using and living in it. Completing the kitchen with all possible convenience items, fulfils your enjoyment.

This makes it worth thinking of Daalderop's smart tap water appliances: the Close-In range. These innovative built-in electric boilers directly deliver hot and boiling tap water. Comfort and convenience you can enjoy on a daily basis.



INSTANT BOILING WATER

Boiling water in a instant

Making tea, preparing soup or cooking dinner, it is all done quicker and more efficiently with a close-in H₂O-TAP. This built-in water heater is combined with a special boiling water tap, providing you with boiling water in an instant. Saving you time, and adding a beautiful design feature.

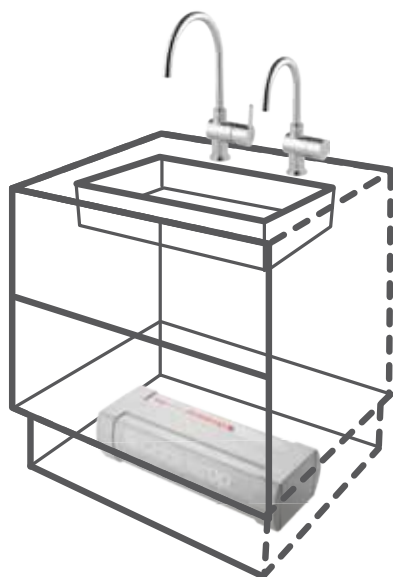

Clean design

The special taps are stylish and can easily be combined with every kitchen style. The entire Close-In® H₂OTAP system not only saves space, but can even add space as a freestanding kettle is no longer necessary. The Close-in® H₂OTAP can fit behind the average plinth, so that you do not have to give up valuable kitchen cabinet space.

Please note: Close-In® H₂OTAP can only be installed horizontally

Advantages Close-in H₂OTAP

- Instant boiling water
- Convenient
- Saves water
- Saves energy
- Safe push-turn knob with built-in recoil spring
- No trailing cables
- Easy to install
- Maintenance-free
- 5 year warranty on sustainable copper boiler*
- 2 year warranty on other parts

- Norit Filtrix watersoftener included
(provides you with an improvement of taste, smell and clear water)

* Excluding lime scale





UNIQUE 3-IN-1 TAP

Direct boiling water in your kitchen combined with a stylish 3-in-1 tap. Only Daalderop supplies this patented and unique tap, that provides you with filtered hot, cold and boiling water. Daalderop offers with this tap even more luxury and comfort in your kitchen without the cost or hassle of having to add another hole in your kitchen top.

The 3-in-1 Tap replaces your current mixer tap and this creates valuable space on your kitchen top. No cables, no kettle and no separate boiling water tap.



Suitable for all kitchens

Want a built-in water heater but not ready for a new kitchen? The 3-in-1 Tap is the perfect solution. This tap fits in the existing hole of your current mixer tap.

Available in Chrome and Stainless Steel.

To ensure harmony in design when selecting the H₂OTAP Daalderop can supply a matching mixertap to perfectly balance the kitchen.

You complete your kitchen with the matching mixer tap for cold and hot water, fitted with one lever control and equipped with a sustainable ceramic disk. This combination of taps ensure perfect harmony on your kitchen top.

PERFECT HARMONY



Chrome

Daalderop

Daalderop

!

SAFETY

OUR HIGHEST

PRIORITY

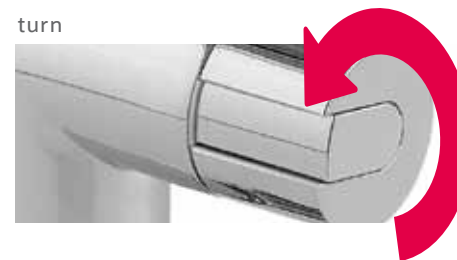

The 3-in-1 Tap is equipped with a child safety feature which uses a recoil spring in the push-turn knob. This patented technique has the advantage that unintentional or unguarded use of the boiling water tap is prevented.

Daalderop has also put thought into the exterior of the tap. The insulated outflow keeps the temperature of the tap itself at a safe level. The 3-in-1 tap contains extra technology: a so-called tube-in-tube system. This system separates the boiling water completely from the cold and hot water.

All Daalderop taps completely rotate and therefore easily used by both left- and right-hand users.



DIRECT HOT WATER

Comfortable and quick

Waiting on hot water in your kitchen belongs to the past and makes room for maximum comfort. With the Close-in fitted kitchen heaters of Daalderop you always have a generous amount of hot water and prevents wastage of water and energy.

No more cold showers

A Daalderop kitchen heater has another great advantage. Not only do you have the perfect solution for instant hot water in the kitchen, but a heater also has

an additional advantage to the bathroom, you can simultaneously use hot water in the bathroom and in the kitchen! If the Daalderop kitchen heater is connected to the cold water mains, you never have a cold shower when the tap in the kitchen is opened.



The kitchen heaters are available in different types, ranging in output, size and ways of installation. Determine with the choice indicator on page 11 and 12 which Close-in which fits best for your situation.

Installation tip: Any Daalderop Close-in can be connected to either the cold or hot water.

Saves water and energy

In the kitchen on average the hot tap is opened 30 to 40 times per day. In most houses the central heating boiler or hot water cylinder are a considerable distance from the kitchen, the hot water has to travel a long distance before the kitchen tap is reached. While you wait for the hot water, the cold water is mostly flushed away unused. And all the time your central heating boiler is producing hot water! That costs a lot of unnecessary water and energy. A Daalderop Close-In boiler allows you water and energy savings. Converted into money that may soon rise up to £ 155 per year!

Tip: Measure your waiting time for hot water with the heat card and see how much you save. Request it through: www.daalderop.co.uk. You could save up to £ 155 a year.

The Daalderop kitchen heaters are extra compact and take up little space. The Close-In Compact even fits behind the kitchen plinth so lose no valuable space in your kitchen cupboard. In a floating kitchen or a kitchen without a plinth, the Close-in Compact can be placed vertically or horizontally in a cupboard.

SAVING SPACE

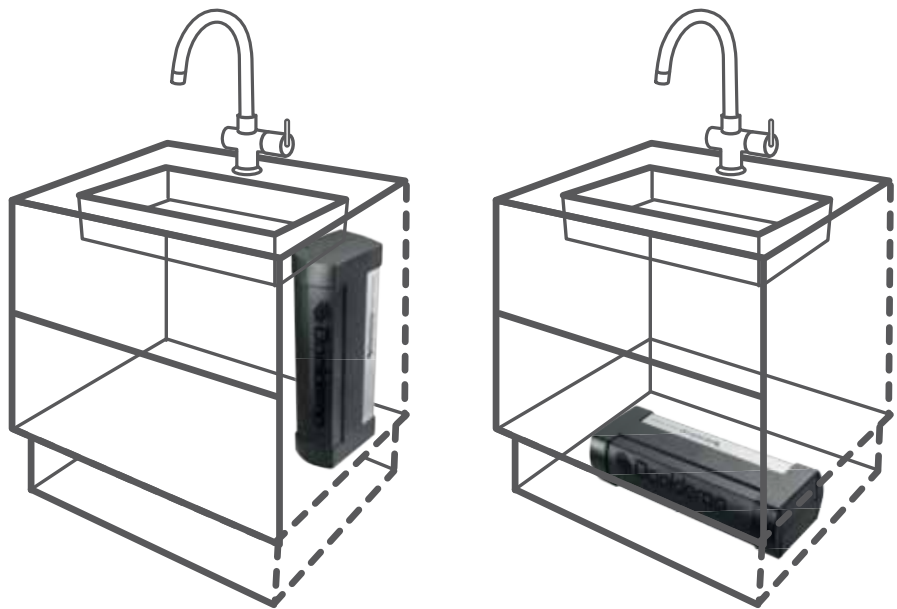

Benefits of the Daalderop kitchen heaters

- Instantaneous hot water without waiting
- Saving money on water and energy up to £ 155* per year!
- Undisturbed showering

* Varies according to tariff.

- Compact dimensions
- Easy to install
- Maintenance-free
-

Five year warranty on durable copper boiler
and two year warranty on other components



































Which heater to choose?

Finding it difficult to choose which Daalderop heater to use?
By using this guide, we will help you make the right choice.

HOT, BOILING-, COLDWATER NEEDS

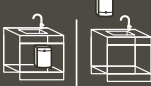
Your expected hot, boiling-, coldwater needs	Product	Heating-up time (ΔT 100°C)	Ways to install	Dimensions (hxwxd) cm	Tap choice	Version	Dimensions mm
Normal use: 2,5 liter	 Close-in® H ₂ otap **	15 min.		14,3 x 55 x 21,1	 Boiling Water Tap Modern 07.90.75.016 	Chrome	Boiling Water Tap h 262 x spout 17,2 Ø 19,3 Ø 35 drill hole
					 Mixing Tap Modern 07.90.75.017 	Chrome	Mixing Tap h 32 x spout 21,2 Ø 19,3 Ø 35 drill hole
					 3-in-1 Tap Modern 07.90.75.018 07.90.75.022 	Chrome Stainless Steel	3-in-1 Tap Modern h 36,3 x spout 18,3 Ø 19,3 Ø 35 drill hole

HOT, COLDWATER NEEDS

Your expected hot water needs	Product **	Heating-up time (ΔT 55°C)	Energy-saving ***	Ways to install	Dimensions (hxwxd) cm
Normal use: 14 litre 	 Close-in® Compact	10 min.*	£ 155,-		14,3 x 55 x 21,1
Normal use: 20 litre 	 Close-in® 10  Close-up® 10	17 min.	£ 155,-		45,2 x 30 x 28,5
Normal+ use: 25 litre 	 Close-in® E 10  Close-up® E 10	17 min.	£ 155,-		45,2 x 30 x 28,5
Normal+ use: 30 litre 	 Close-in® 15  Close-up® 15	26 min.	£ 155,-		45,2 x 30 x 28,5
Comfort use: 35 litre 	 Close-in® E 15  Close-up® E 15	26 min.	£ 155,-		45,2 x 30 x 28,5
Comfort use: a lot 	 Close-in® Compact (hot-fill connected)	none	£ 90,-		14,3 x 55 x 21,1

*** Calculation based on BS 5129, Energy saving per year.

* For horizontal placement, the warm-up time 13 minutes. | ** Output is 2200W.

DAALDEROP SUSTAINABLE COMFORT

Through continuously focusing on innovation and product performance Daalderop has been the Netherlands' market leader for a long time in the area of hot and boiling water equipment. All products guarantee comfort, smart and compact design for an accessible price. This is what Daalderop calls: sustainable comfort.



Daalderop UK
10 Faraday Court
First Avenue
Centrum 100
Burton on Trent
Staffordshire
DE14 2WX
Tel. +44 (0)11 593 75 179
E-mail: info@daalderop.co.uk
www.daalderop.co.uk

